

# Your Ultimate Source for OEM Repair Manuals

FactoryManuals.net is a great resource for anyone who wants to save money on repairs by doing their own work. The manuals provide detailed instructions and diagrams that make it easy to understand how to fix a vehicle.

## 2022 Volvo V60 Cross Country Service and Repair Manual

[Go to manual page](#)

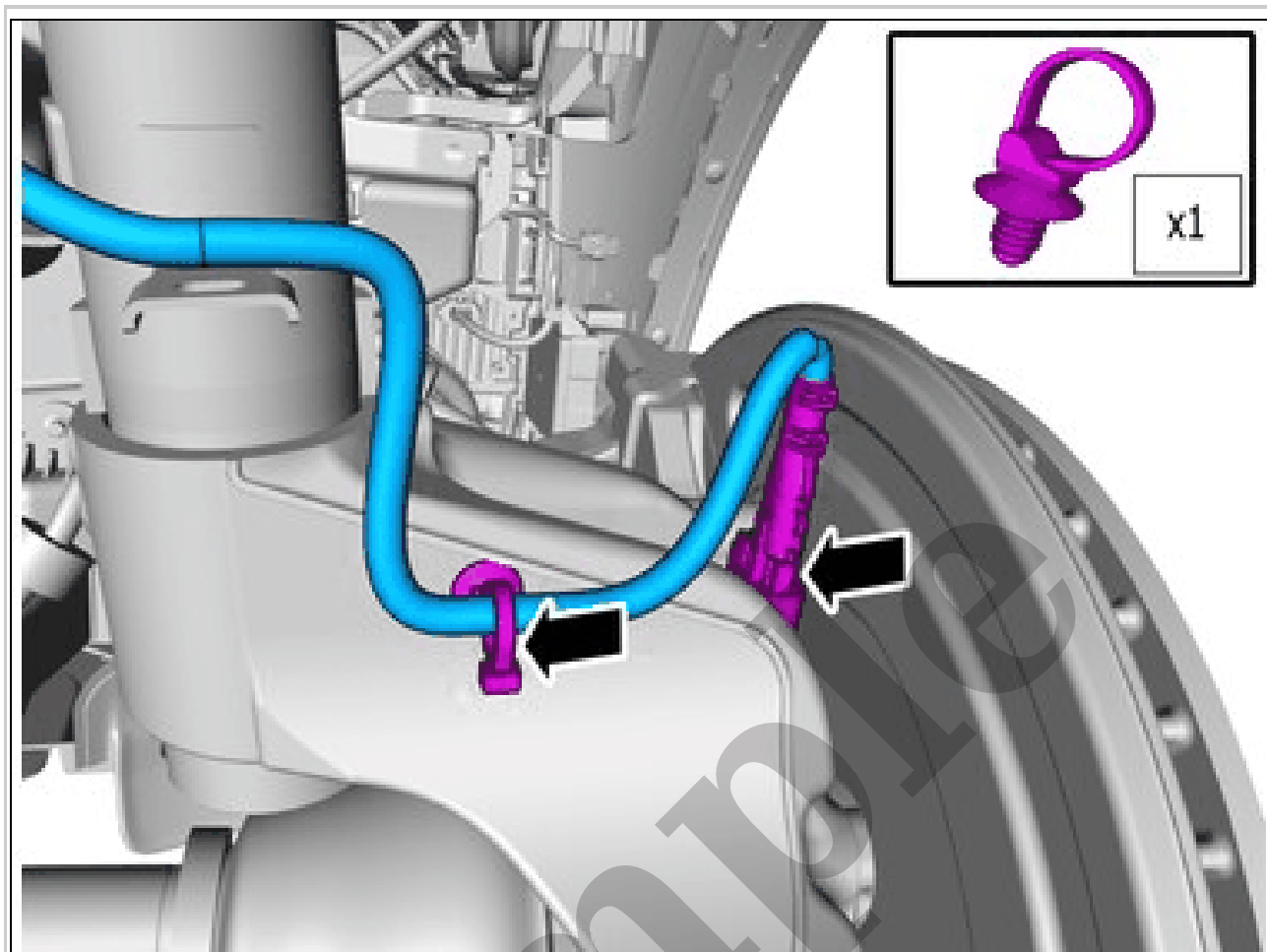

Courtesy of VOLVO CARS CORPORATION

Connect the connector.  
Install the clip(s).

**NOTE:** *Test drive where other traffic will not be disrupted*

The test drive must include at least one right-hand and one left-hand turn (more than 45 degrees), at least a 100 meters stretch and a braking from 50 km/h to rest with ABS control. The test is passed if the DSTC system does not illuminate any lamp (Warning lamp for wheel spin, ABS lamp or the general brake warning lamp).

Sample

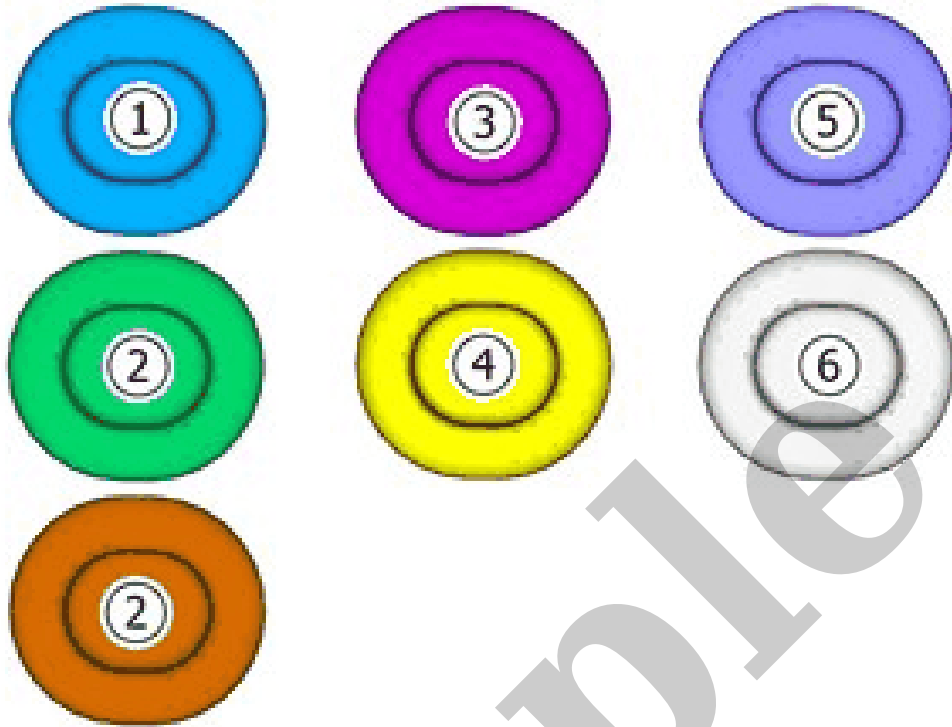

Courtesy of VOLVO CARS CORPORATION

**NOTE:** This color chart displays (in color print and electronic version) the importance of the different colors used in the images of the method steps.

1. Used for focused component, the component with which you will do something.
2. Used as extra colors when you need to show or differentiate additional parts.
3. Used for attachments that are to be removed/installed. May be screws, clips, connectors, etc.
4. Used when the component is not fully removed from the vehicle but only hung to the side.
5. Used for standard tools and special tools.
6. Used as background color for vehicle components.

#### **ACCESSORY INSTALLATION**

VIDA/Information/Repair/Removal, replacement and installation/Brakes/Brake control system/anti-lock brake (anti-skid)/Hydraulic unit brake system

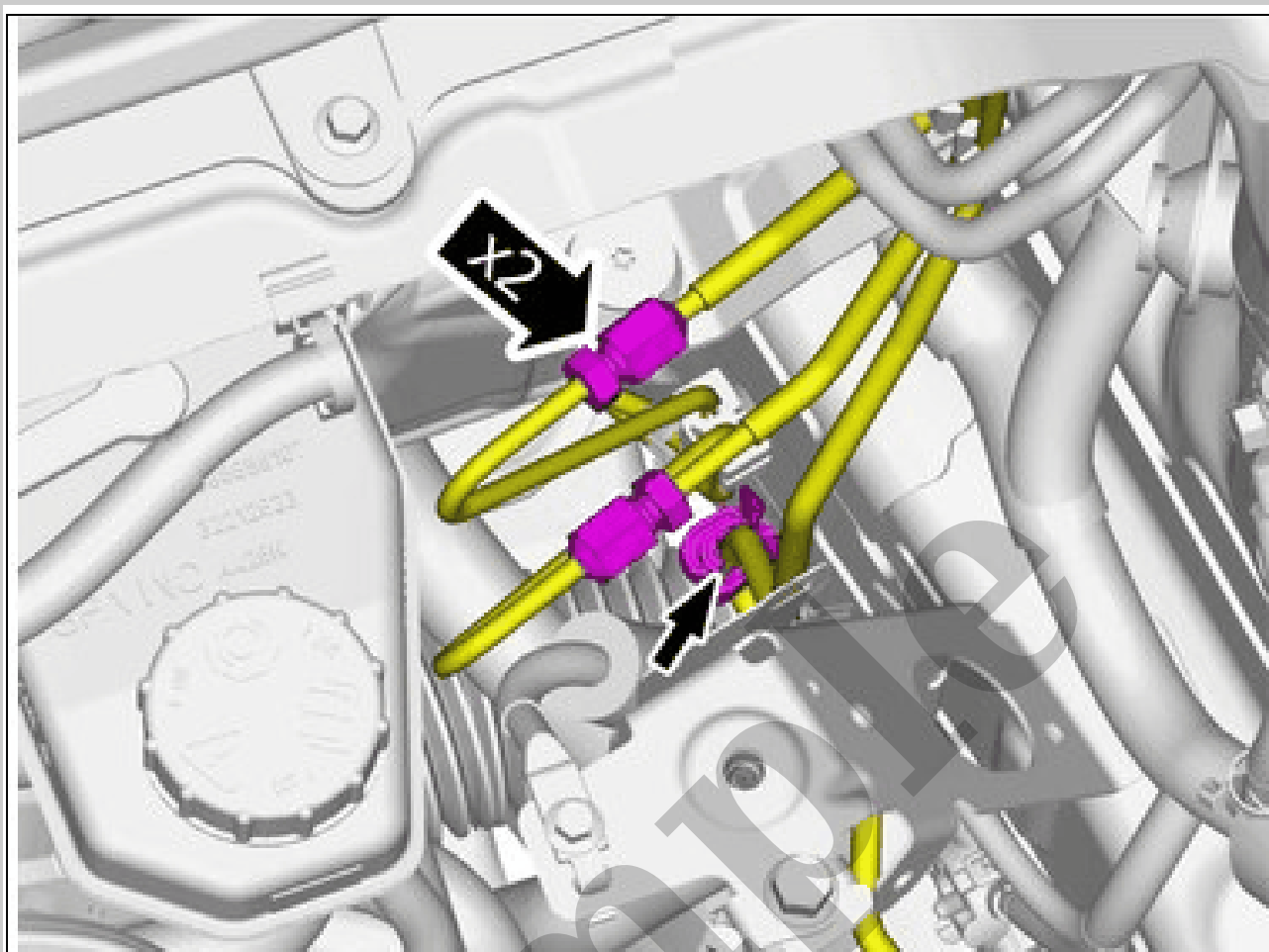

Courtesy of VOLVO CARS CORPORATION

**WARNING:** *Be prepared to collect escaping fluid.*

Loosen the nuts.

Loosen the marked details.

Loosen the marked details from the clip/clips.

**Torque:** Ø6 mm diameter brake line, 14Nm

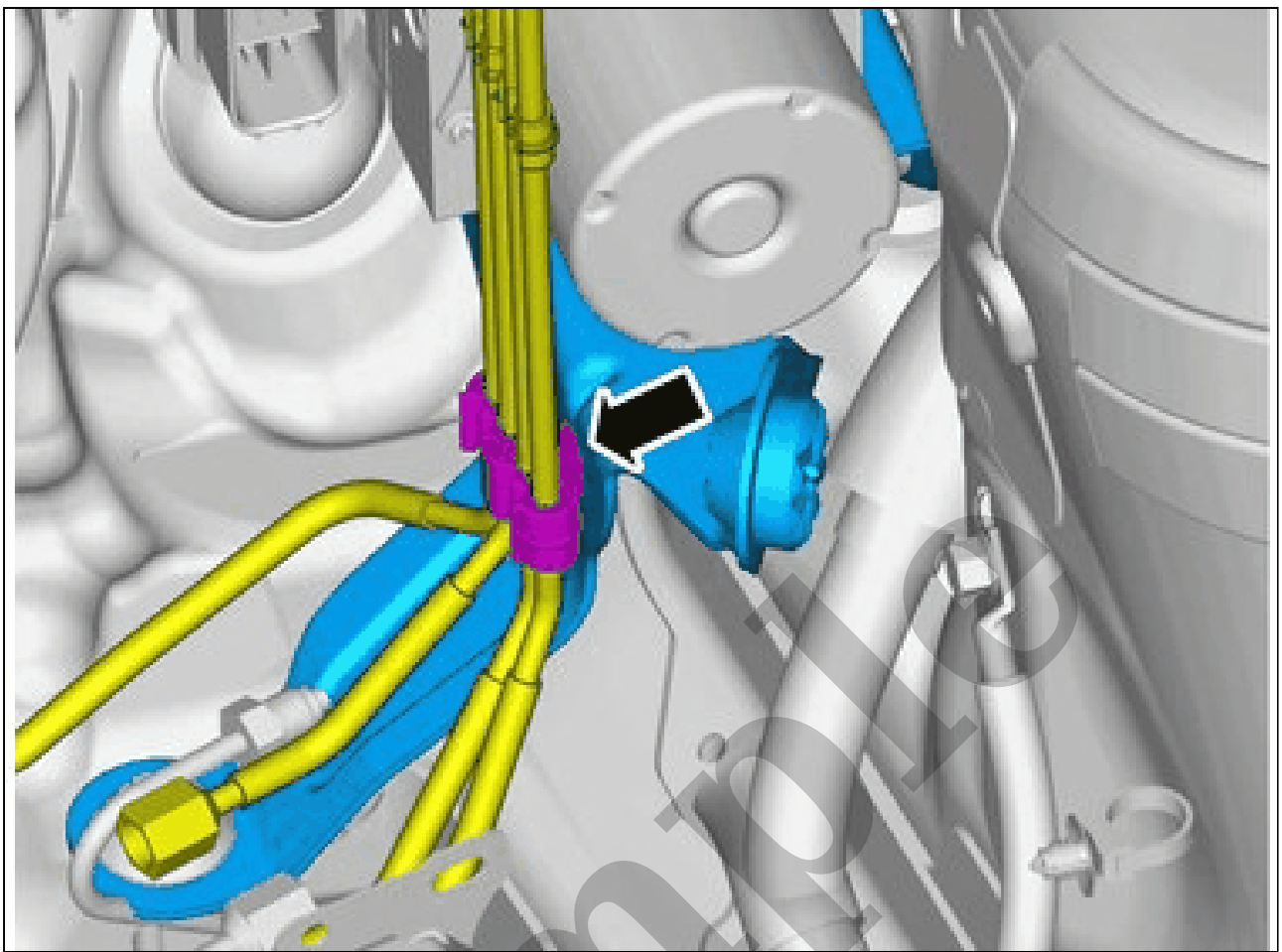

Courtesy of VOLVO CARS CORPORATION

Loosen the clip.

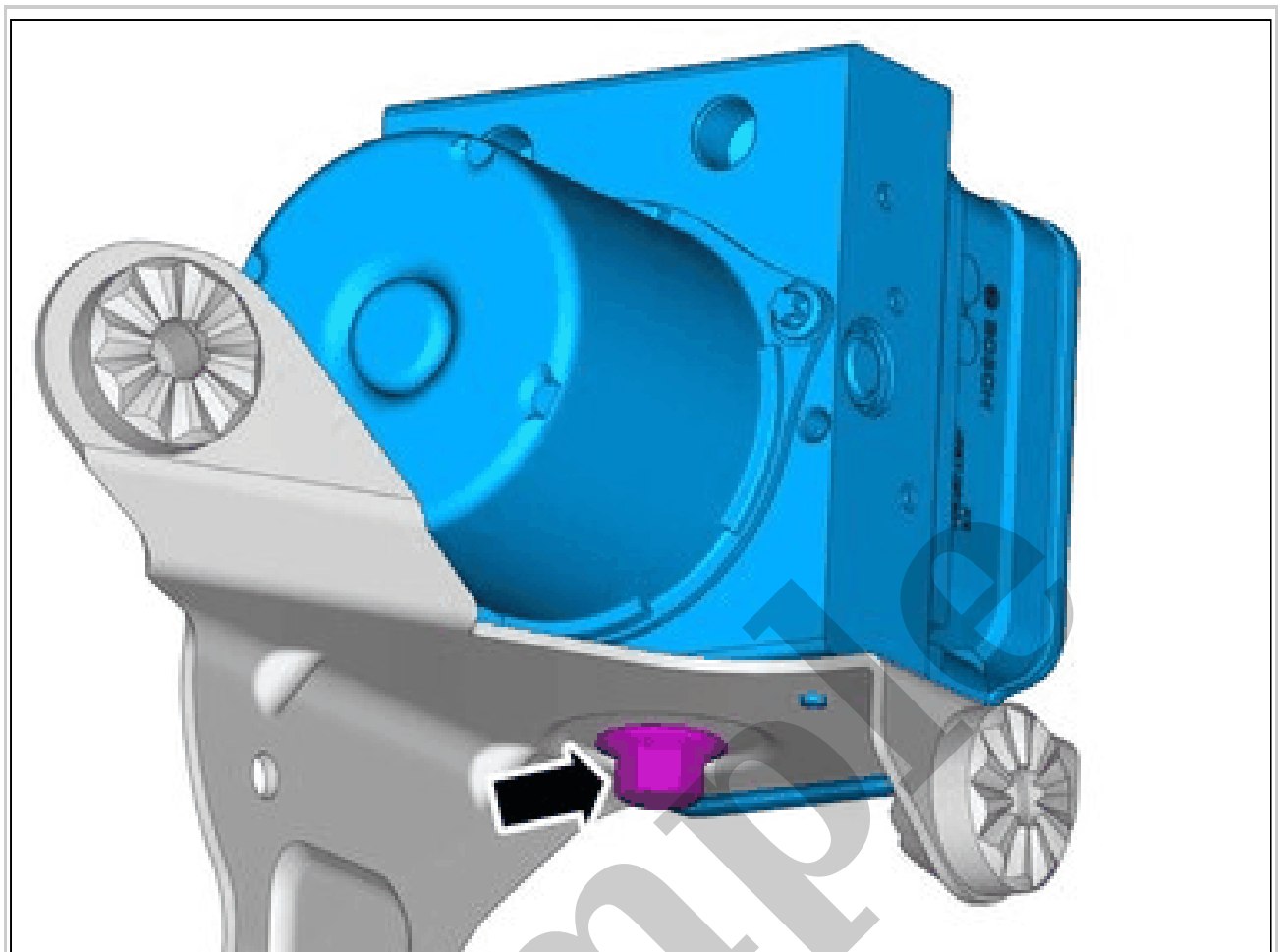

Courtesy of VOLVO CARS CORPORATION

Remove the screw.  
Remove the marked part.

**HYDRAULIC UNIT BRAKE SYSTEM > HYDRAULIC UNIT BRAKE SYSTEM [2018-2022,  
B4204T18 | 2019-2022, B4204T47] > INSTALLATION**

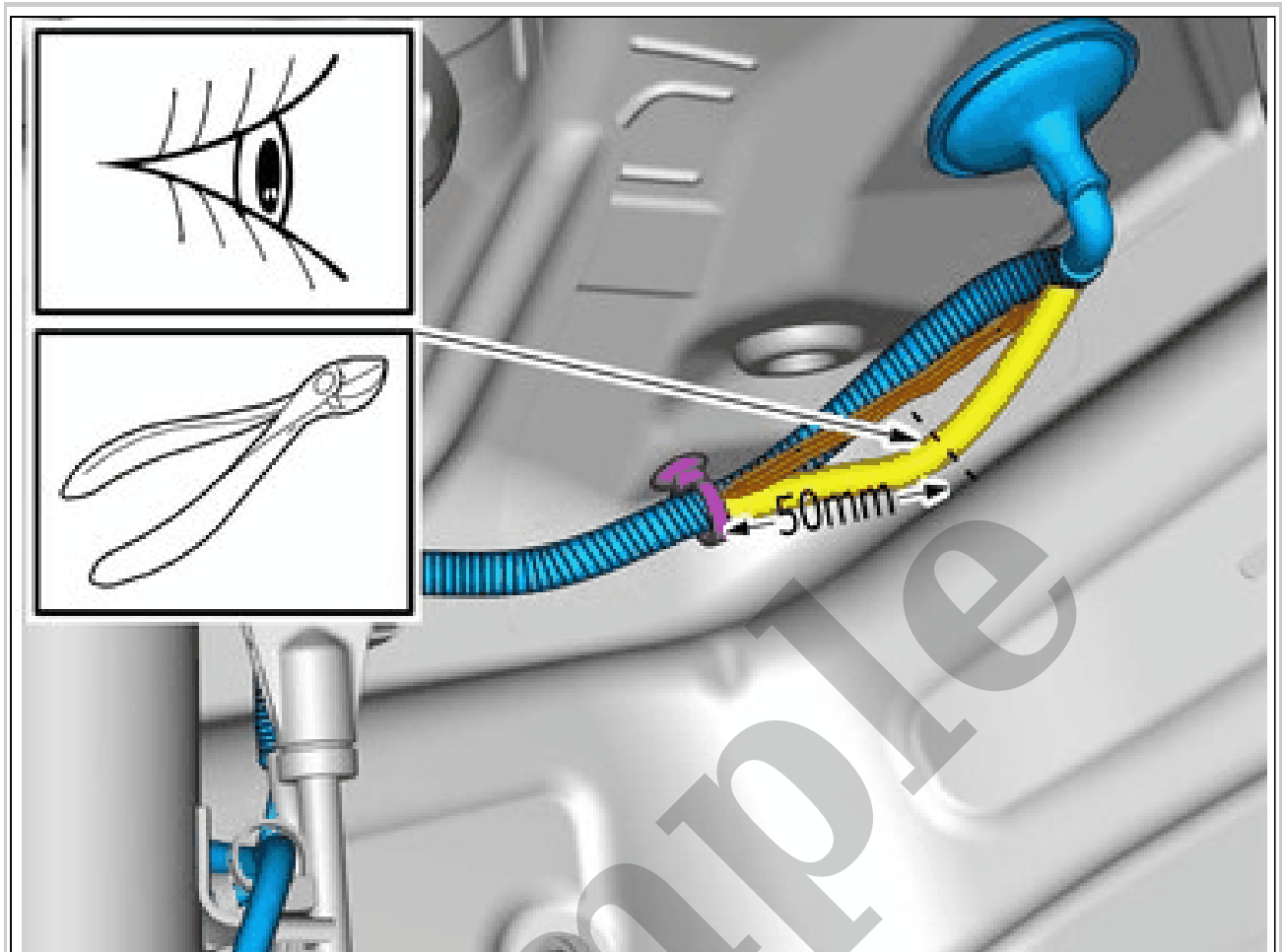

Courtesy of VOLVO CARS CORPORATION

**CAUTION:** *Ensure that the cable/cables are not damaged.*

Cut following the dotted lines.

**Use:** Cutting pliers



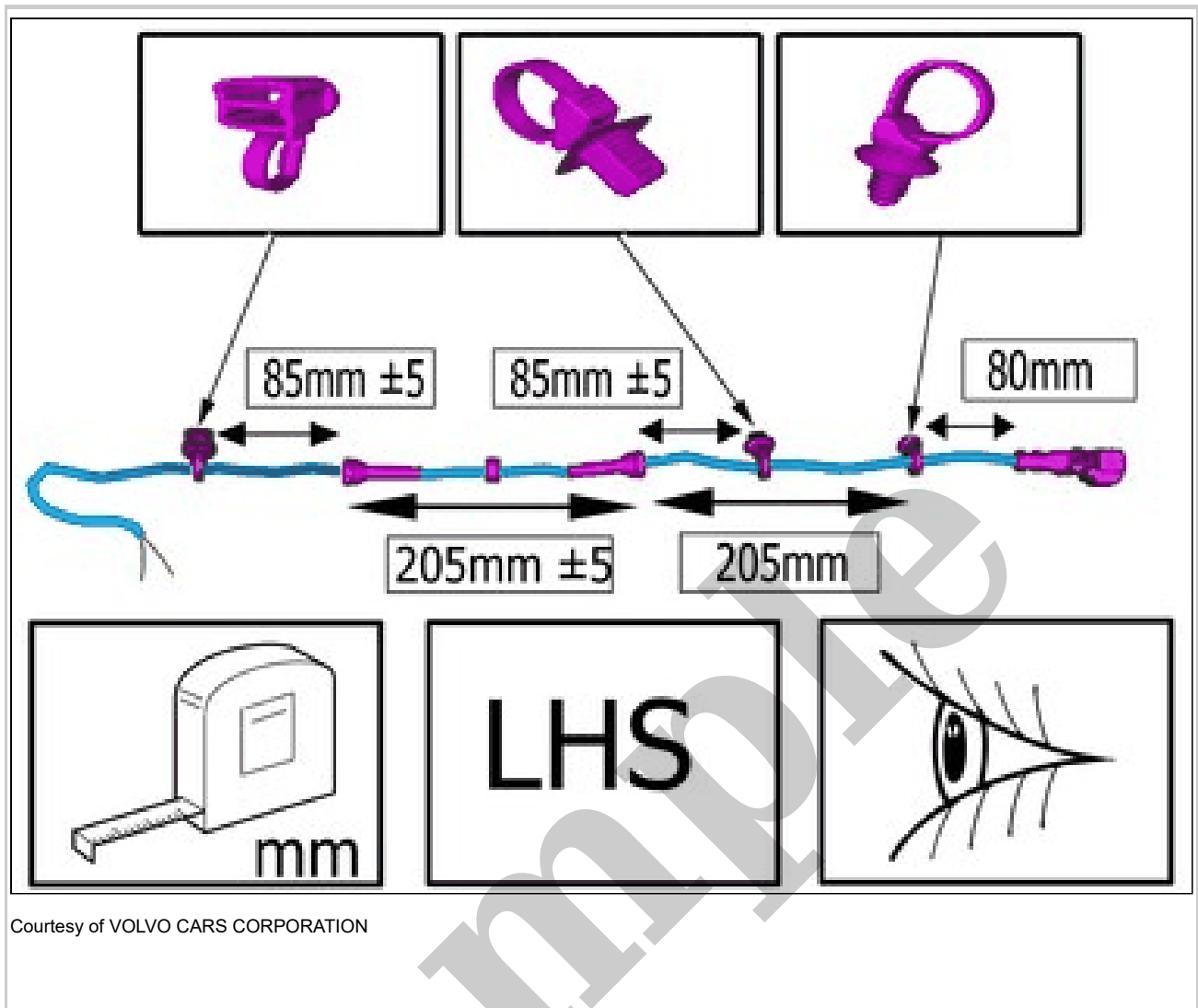

Courtesy of VOLVO CARS CORPORATION

**NOTE:** Make sure that a new component is installed.

1. Measure distance from rubber fixation to clips.

2. Adjust to the specified value.

**Use:** Tape measure

**REPAIR**

See information about splicing cables. Refer to: JOINING CABLES

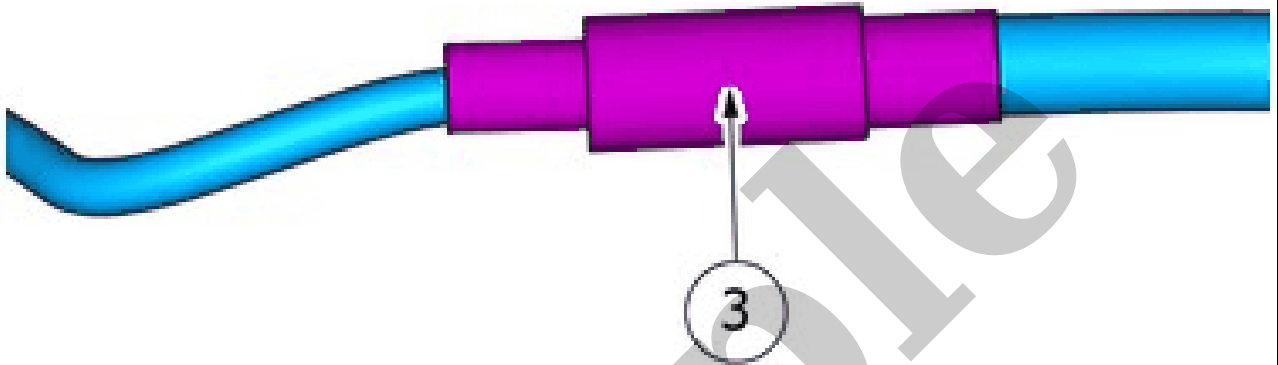
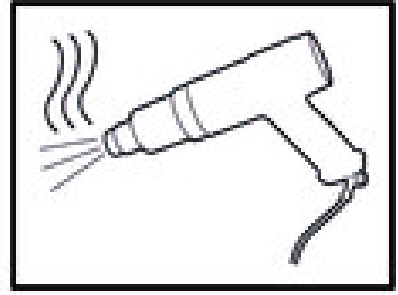
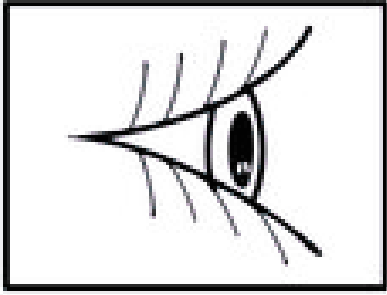

Courtesy of VOLVO CARS CORPORATION

**Use:** heat-shrinkable tubing, 976422  
**Use:** Hot-air gun  
**INSTALLATION**