

Your Ultimate Source for OEM Repair Manuals

FactoryManuals.net is a great resource for anyone who wants to save money on repairs by doing their own work. The manuals provide detailed instructions and diagrams that make it easy to understand how to fix a vehicle.

1969 FORD Thunderbird OEM Service and Repair Workshop Manual

[Go to manual page](#)

2. Connect the battery ground cable.

Refer to: [Battery Disconnect and Connect](#)(414-01 Battery, Mounting and Cables, General Procedures).

Disconnect

NOTICE

When reusing liquid tube connectors, make sure to use compressed air to remove any foreign material from the connector retaining clip area before separating from the tube or damage to the tube or connector retaining clip may occur.

NOTICE

Fuel injection equipment is manufactured to very precise tolerances and fine clearances. It is essential that absolute cleanliness is observed when working with these components or component damage may occur. Always install blanking plugs to any open orifices or tubes.

NOTICE

Do not use any tools. The use of tools may cause a deformity in the clip components which may cause fuel leaks.

NOTE

Type 18

1. If servicing a liquid fuel tube quick release coupling, release the fuel system pressure.

Refer to: [Fuel System Pressure Release](#)(310-00B Fuel System - General Information - 3.3L Duratec-V6, General Procedures).

2. Disconnect the battery ground cable.

Refer to: [Battery Disconnect and Connect](#)(414-01 Battery, Mounting and Cables, General Procedures).

3.

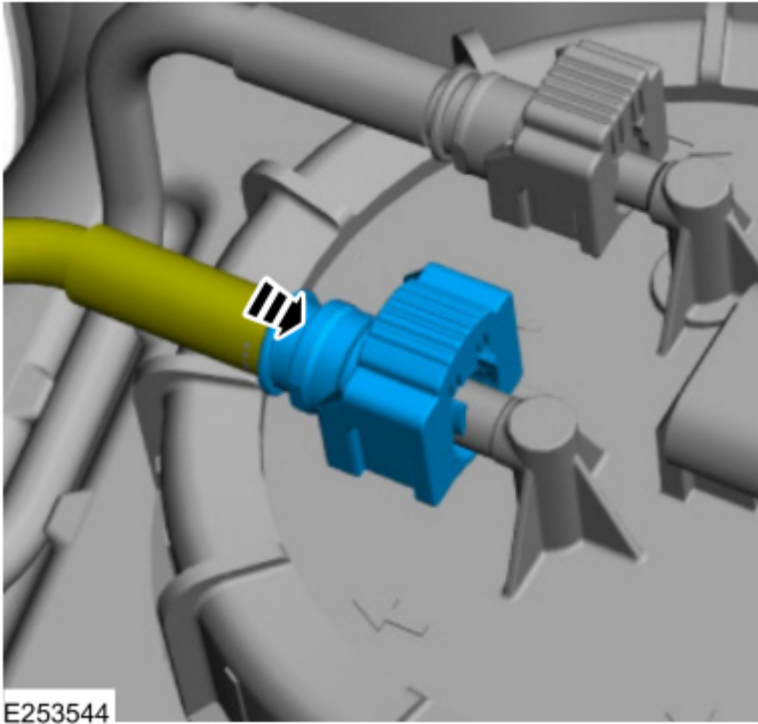

[Click here to learn about symbols, color coding, and icons used in this manual.](#)

2. Connect the battery ground cable.

Refer to: [Battery Disconnect and Connect](#)(414-01 Battery, Mounting and Cables, General Procedures).

Disconnect

NOTICE

When reusing liquid tube connectors, make sure to use compressed air to remove any foreign material from the connector retaining clip area before separating from the tube or damage to the tube or connector retaining clip may occur.

NOTICE

Fuel injection equipment is manufactured to very precise tolerances and fine clearances. It is essential that absolute cleanliness is observed when working with these components or component damage may occur. Always install blanking plugs to any open orifices or tubes.

NOTICE

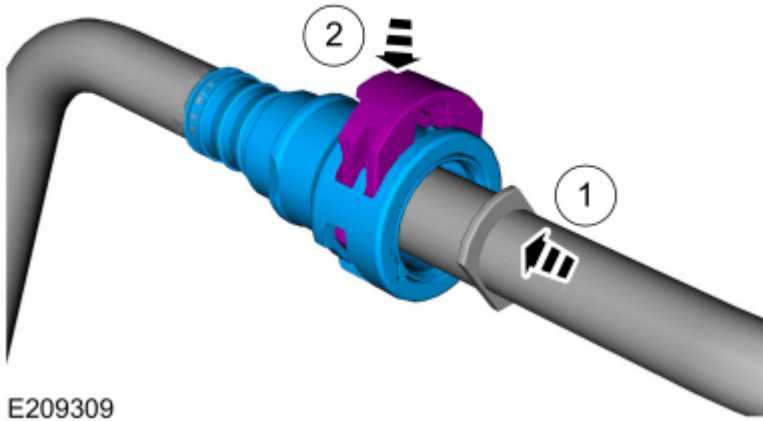

[Click here to learn about symbols, color coding, and icons used in this manual.](#)

2. Connect the battery ground cable.

Refer to: [Battery Disconnect and Connect](#)(414-01 Battery, Mounting and Cables, General Procedures).

Disconnect

NOTICE

When reusing liquid tube connectors, make sure to use compressed air to remove any foreign material from the connector retaining clip area before separating from the tube or damage to the tube or connector retaining clip may occur.

NOTICE

Fuel injection equipment is manufactured to very precise tolerances and fine clearances. It is essential that absolute cleanliness is observed when working with these components or component damage may occur. Always install blanking plugs to any open orifices or tubes.

NOTICE

Do not use any tools. The use of tools may cause a deformity in the clip components which may cause fuel leaks.

NOTE

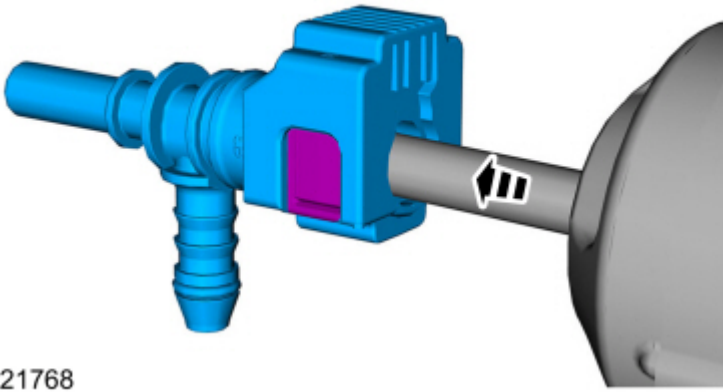

E221768

[Click here to learn about symbols, color coding, and icons used in this manual.](#)

2. Connect the battery ground cable.

Refer to: [Battery Disconnect and Connect](#)(414-01 Battery, Mounting and Cables, General Procedures).

Disconnect

NOTICE

When reusing liquid tube connectors, make sure to use compressed air to remove any foreign material from the connector retaining clip area before separating from the tube or damage to the tube or connector retaining clip may occur.

NOTICE

Fuel injection equipment is manufactured to very precise tolerances and fine clearances. It is essential that absolute cleanliness is observed when working with these components or component damage may occur. Always install blanking plugs to any open orifices or tubes.

NOTICE

Do not use any tools. The use of tools may cause a deformity in the clip components which may cause fuel leaks.

NOTE

E209310

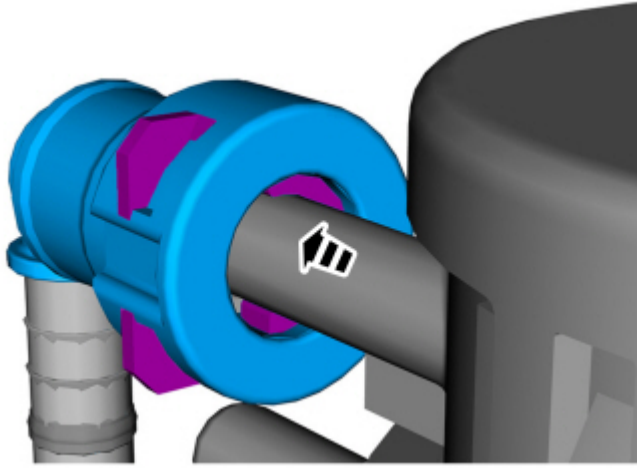

[Click here to learn about symbols, color coding, and icons used in this manual.](#)

2. Connect the battery ground cable.

Refer to: [Battery Disconnect and Connect](#)(414-01 Battery, Mounting and Cables, General Procedures).

Disconnect

NOTICE

When reusing liquid tube connectors, make sure to use compressed air to remove any foreign material from the connector retaining clip area before separating from the tube or damage to the tube or connector retaining clip may occur.

NOTICE

Fuel injection equipment is manufactured to very precise tolerances and fine clearances. It is essential that absolute cleanliness is observed when working with these components or component damage may occur. Always install blanking plugs to any open orifices or tubes.

NOTICE

Do not use any tools. The use of tools may cause a deformity in the clip components which may cause fuel leaks.

NOTE

2. 1. **NOTE**

Pull on the quick release coupling and the fitting to make sure it is securely fastened.

Snap the locking tab into place.

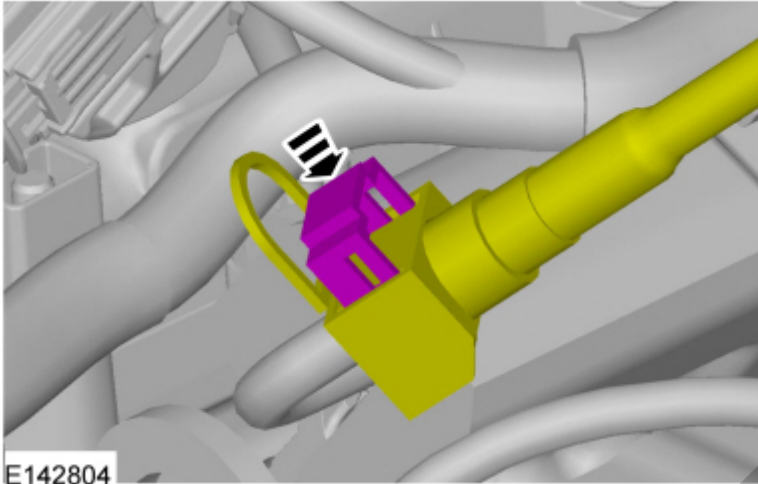

[Click here to learn about symbols, color coding, and icons used in this manual.](#)

3. **NOTICE**

Make sure that all fuel connections are checked for leaks.

NOTE

This step is only necessary if a new component is installed.

1. **NOTE**

Pull on the quick release coupling and the fitting to make sure it is securely fastened.

Snap the locking tab into place.

Type 23

1. If servicing a liquid fuel tube quick release coupling, release the fuel system pressure.

Refer to: [Fuel System Pressure Release](#)(310-00B Fuel System - General Information - 3.3L Duratec-V6, General Procedures).

2. Disconnect the battery ground cable.

Refer to: [Battery Disconnect and Connect](#)(414-01 Battery, Mounting and Cables, General Procedures).

- 3.

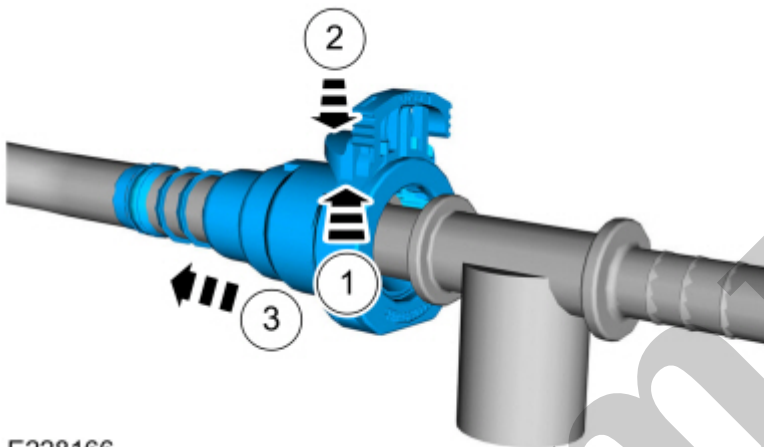

E228166

[Click here to learn about symbols, color coding, and icons used in this manual.](#)

Connect

1. NOTE

Make sure the retainer clip is fully seated and locked onto the tube by pulling on the quick connect coupling.

1. NOTE

Pull on the quick release coupling and the fitting to make sure it is securely fastened.

Snap the locking tab into place.

Type 24

1. If servicing a liquid fuel tube quick release coupling, release the fuel system pressure.

Refer to: [Fuel System Pressure Release](#)(310-00B Fuel System - General Information - 3.3L Duratec-V6, General Procedures).

2. Disconnect the battery ground cable.

Refer to: [Battery Disconnect and Connect](#)(414-01 Battery, Mounting and Cables, General Procedures).

3.

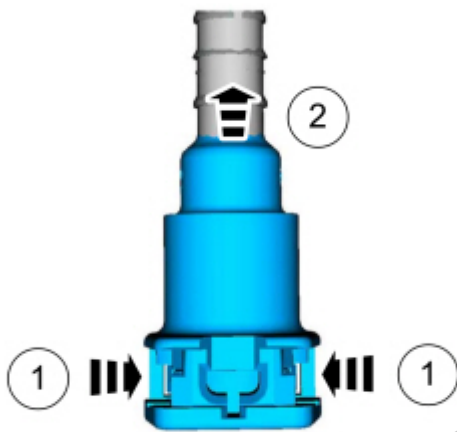

E228168

[Click here to learn about symbols, color coding, and icons used in this manual.](#)

Connect

1. 1. **NOTE**

Pull on the quick release coupling and the fitting to make sure it is securely fastened.

Snap the locking tab into place.

Type 25

1. If servicing a liquid fuel tube quick release coupling, release the fuel system pressure.

Refer to: [Fuel System Pressure Release](#)(310-00B Fuel System - General Information - 3.3L Duratec-V6, General Procedures).

2. Disconnect the battery ground cable.

Refer to: [Battery Disconnect and Connect](#)(414-01 Battery, Mounting and Cables, General Procedures).

3.
 1. Depress the clip into the quick release coupling.
 2. Separate the quick release coupling from the tube.

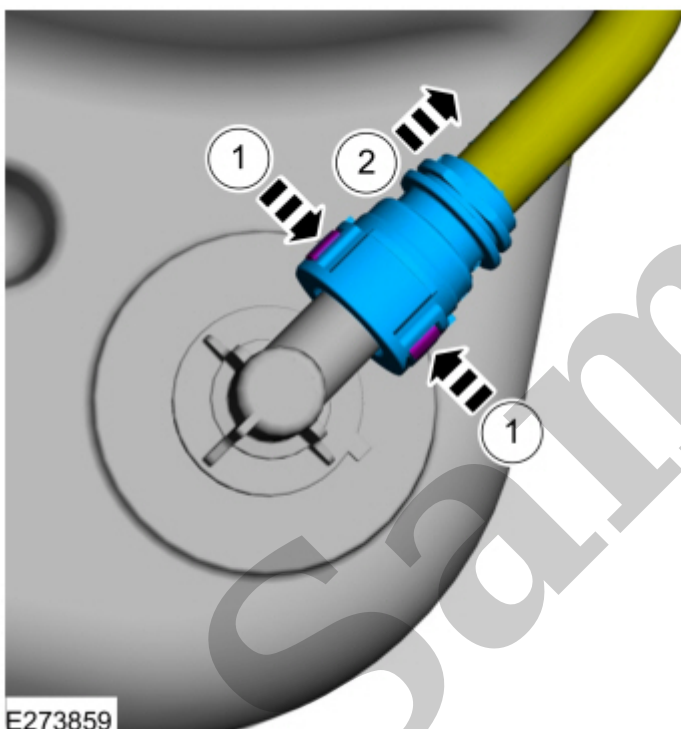

[Click here to learn about symbols, color coding, and icons used in this manual.](#)

Connect

1.
 - 1.

NOTE

Pull on the quick release coupling and the fitting to make sure it is securely fastened.

Snap the locking tab into place.